

# Elegant

WINDOW FASHIONS

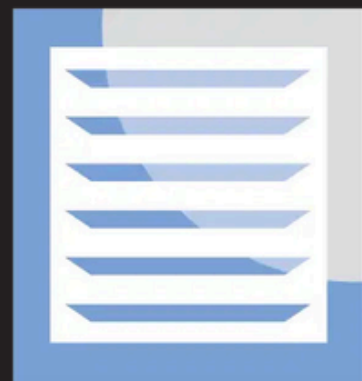

chelsea

WOOD SHUTTERS

PRODUCT GUIDE 2026

# COLORS



01 White



02 Dusk



03 Mushroom



05 Oyster



06 Sea Pearl



07 Picaso



09 Lustre



31 Cashew Nut

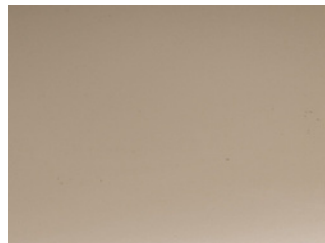

32 Almond Grey



33 Blue Glacier

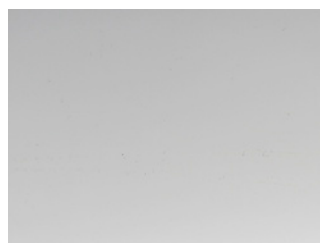

34 Space Grey

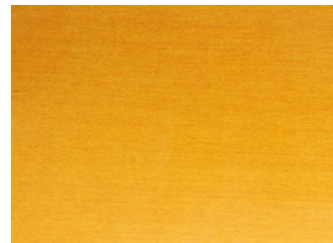

61 Golden Oak



62 Fruitewood



64 Coffeccc Bean



65 Black Walnut



66 Light Ash



68 Natural



70 Provence Blue



72 Rustic



74 Taupe

## Product Color Disclaimer

Please note: The colors of images shown on our website may vary and appear different from the actual products due to differences in screen settings, lighting, and other factors.

While we strive to ensure accuracy, variations may occur.

For a more accurate representation, we recommend ordering our Sample Bag to experience the true colors, textures, and quality of our products first hand.

## PANEL SPECIFICATIONS

Properties	Specifications
Minimum Panel/ Opening Width	6"
Minimum Panel/ Opening Height	10"
Maximum Hinge panel/ Opening width	37"
Maximum Hinge Bi-fold panel/ Opening width	26"
Maximum track Bi-Fold panel/ Opening width	26"
Maximum Bypass single panel width	36"
Maximum Bypass Center stile panel width	47"
Maximum panel height/opening height	118"
Maximum panel height without Divider rail	70"

## TRACK SYSTEM INFORMATION

Track Valance Bypass Fascia	Outside	Inside
Bi-fold Fascia	5.5	4"
<b>Track Frame</b>	4"	2.5"
Track- Bi-fold Box Out Board (thickness)	Front	Back
Bypass Box Out Board (thickness)	0.75"	1.75"
	0.75"	1.75"

## FACTORY DEDUCTIONS

IM Z Frame	0.375" from total width and 0.375" from total height. 0.25" from total width
IM L Frame (recommended deduction)	and 0.25" from total height.
Bay Window with Z frame	0.9375" from width of left side of bay, nil from center, 0.9375" from width of right side of bay: 0.1875" from total height ( all deductions are from back of frame).
Bay Window with L frame	0.0625" from width of left side of bay, nil from center, 0.0625" from width of right side of bay: 0.125" from total height.
Corner window with Z frame	0.9375" from width of left corner, 0.9375" from width of right side of corner and 0.1875" from total height.
Corner window with L frame	0.0625" from width of left side of corner, 0.0625" from right width side of corner and 0.125" from total height.

## LOUVER CLEARANCES

Louver	2.5"	3.5"	4.5"
Front Tilt Rod/ Gear System	0.625"	1.125"	1.625"
Hidden Tilt	0.6375"	1.4375"	1.9375"
Max. # of Louvers in hidden tilt	19	13	10
Max. # of Louvers in invisible tilt	15	10	8

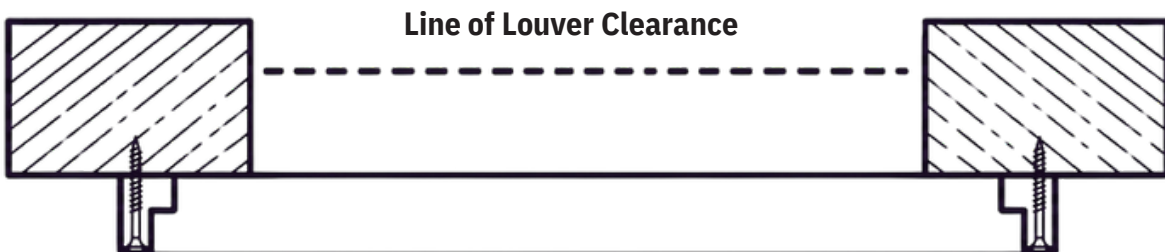

## Window Size / Inside Mount

When specifying window size or opening size, and inside mount on your order, the factory will take a deduction between the frame and the reveal from each side of both the width and the drop when manufacturing your shutters.

When measuring the opening size:

1. Ensure that the opening depth will allow louvers to rotate freely
2. Measure to the inside width in three different places
3. Measure to the inside height in three different places
4. Record the smallest of the three measurements for each
5. Check for window squareness



Inside Mount L Frame

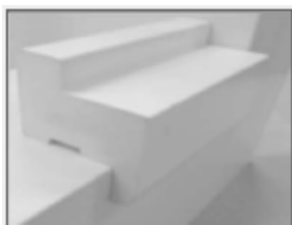

Inside Mount Z Frame

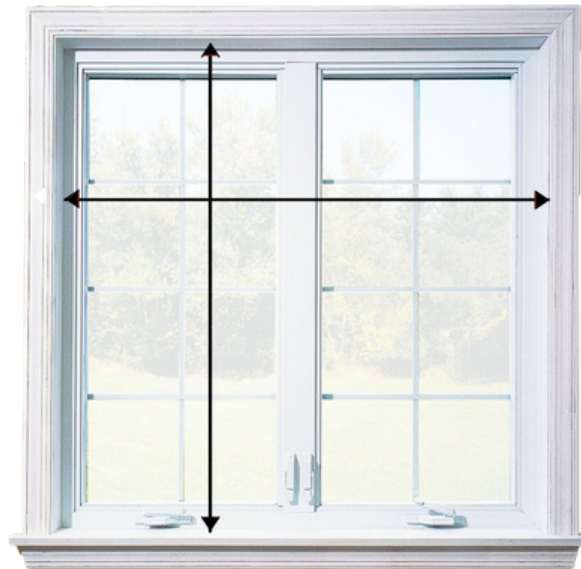

## Finish Size/ Outside Mount

When specifying the finished size or make size on your order, the factory will NOT take any deduction and the shutter unit. Frames will be manufactured to your exact width and height specifications to the outside edge of the frame.

When measuring the make size:

1. Ensure that the opening depth will allow louvers to operate
2. Measure width from outside of the frame to the outside of the frame in three different places
3. Measure the height from outside of the frame to outside of the frame in three different places
4. Record the smallest of the three measurements for each ~
5. Check for window squareness

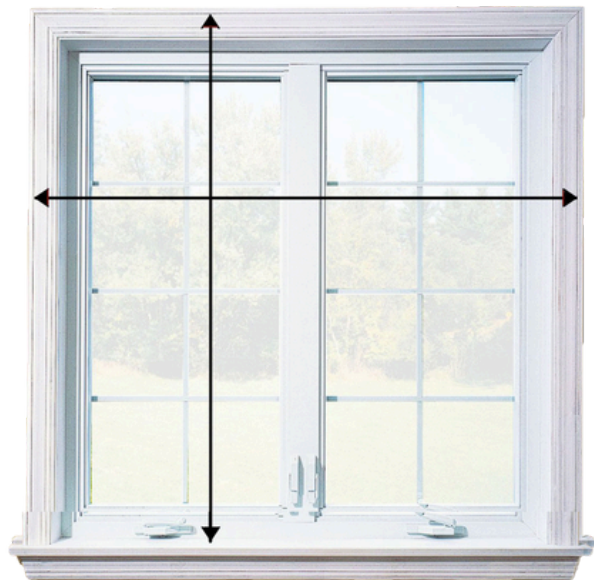
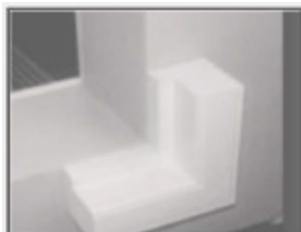

# HINGE TYPES

## Hinged Panels

Panels can be hinged inside mount with L Frame or Z Frame using Non-Mortise Hinges, and outside mount with L Frame or Deco Frame.

Hinges are painted to match the color of the shutter or available in other metal finishes. (surcharge applies for Stainless).

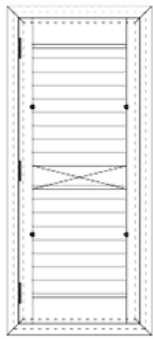

L



HINGE LEFT

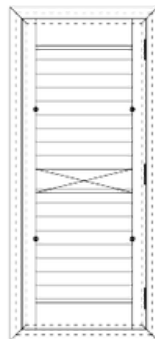

R



HINGE RIGHT

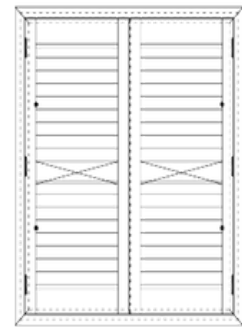

LR

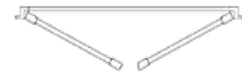

HINGE (L R)

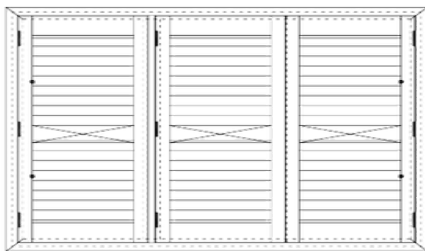

LTLR



L-T-L-R (1x T Posts; 3 x panels)

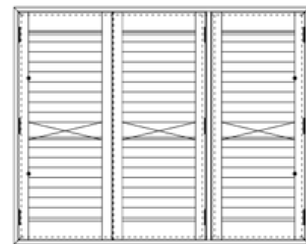

LRTR



L-R-T-R (1 x T Posts; 3 x panels)

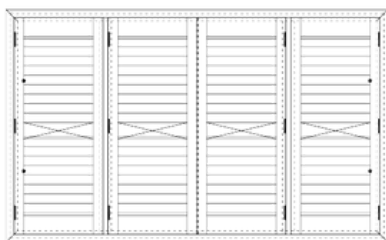

LTLRTR

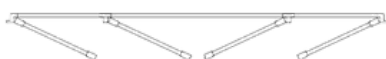

L-T-L-R-T-R

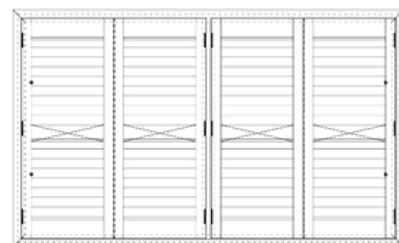

LRTLR



L-R-T-L-T-R

## HINGE TYPES

### BI-Fold Hinged

The Bi-Fold hinge design enables two panels to be joined and folded against each other, offering an unobstructed view from the window or doorway.

NOTE: Bi-Fold panels should not be left swung open for extended periods of time.



RR



R-R

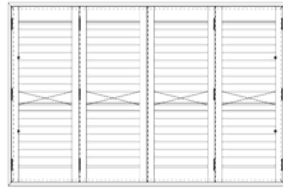

LLRR



L-L-R-R

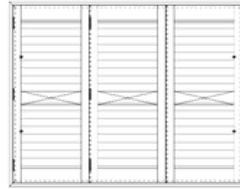

LLR



R-R-L

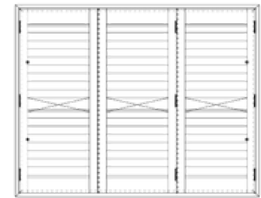

LRR



L-R-R

### Double Hung/ Tier on Tier/ Saloon Style

Shutters featuring an upper set of panels and a lower set, optionally with a horizontal T Post, may incur an additional surcharge.

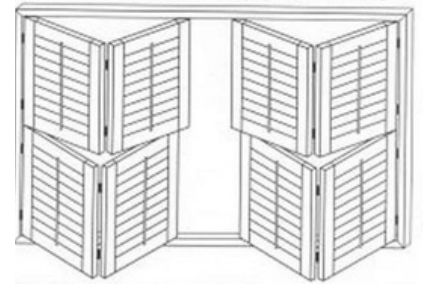

## STRIPS

### Light Block Strip

This material can serve as beading for fixed panels, a light block behind direct mount panels, and for securing pelmets and fascia on Bypass and Bi-Fold configurations.

Custom buildouts are also an option for tailored solutions.



### Hanging Strip

When utilized as a light block, it effectively covers light gaps or serves as a build-out component.

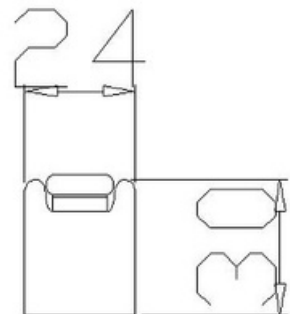

## T - P O S T

Divides a window vertically into sections or to match window mullions to allow panel configurations that require more than two panels. Can be used with any of our frame styles and locations can be customized. 2inch and custom T - Post also available.

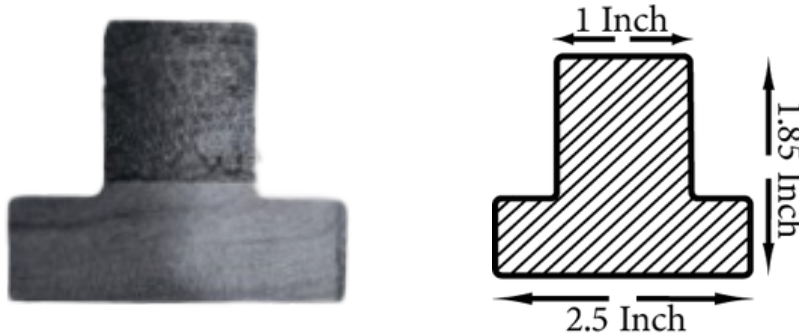

### Window Size- Inside Mount

Position 1 - Measure from left side of inside the window to center of the first T-Post location.

Position 2 - Measure from the far left of inside the window to the center of each T-Post.

### Finish Size / Outside Mount

Position 1 - Measure from the left edge of the frame to the center of the first T-Post.

Position 2 - Measure from the far left of the frame to the center of each T-Post.

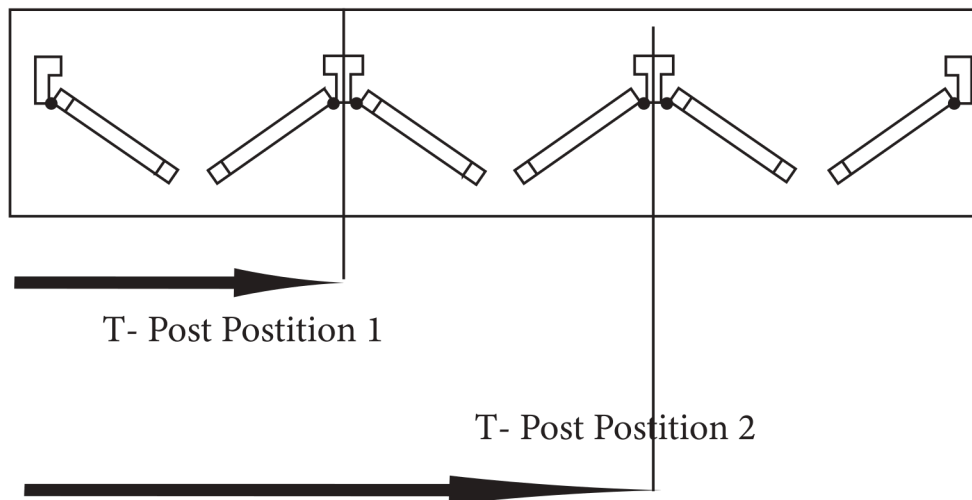

### Horizontal T-Post

Required when multiple shutters are needed to cover large window heights and when panels exceed 118" in height.

### Window Size / Inside Mount

Measure from the bottom window edge to the center of the T-Post for Position 1.

### Finished Size / Outside Mount

Measure from the bottom edge of the frame to the center of the T-Post.

## STILE TYPES

### Astragal Stile

Effectively conceals light gaps at the junctions of hinged panels and offer greater flexibility for windows that are not perfectly square.

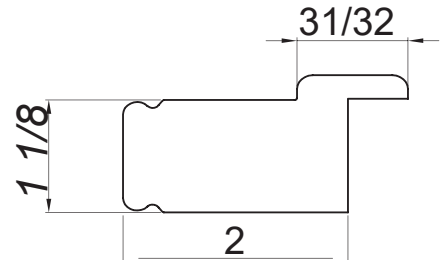

### Rabbeted Stile

Enables panels to close seamlessly, making them ideal for Bi-Fold panels.

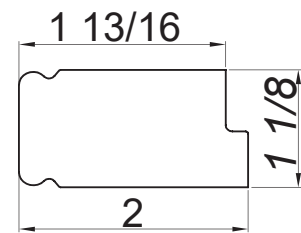

### Square Stile

Standard for Bypass panels and single hinged panels

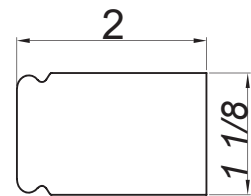

### Flat Square Stile

Used for a more contemporary look.

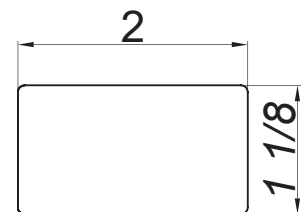

# FRAME TYPES

L FRAME 50

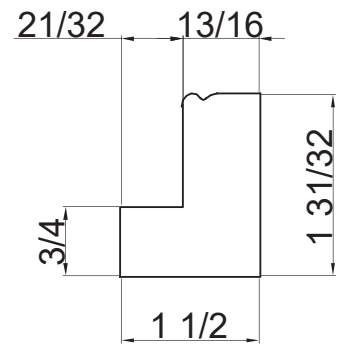

SL10

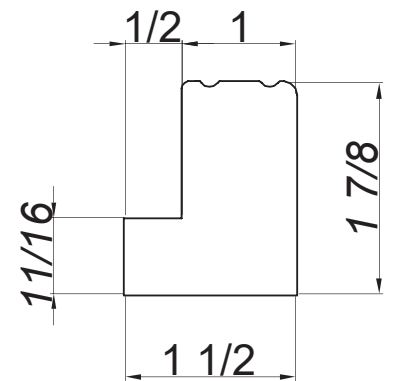
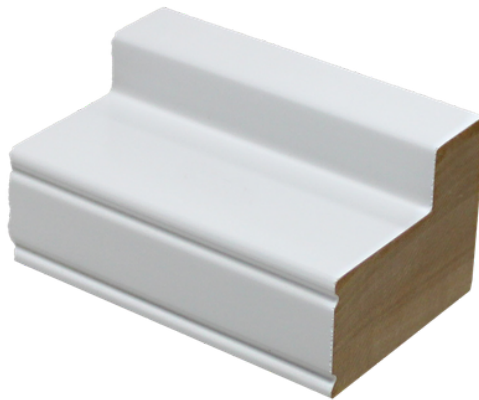

L FRAME CAP 54

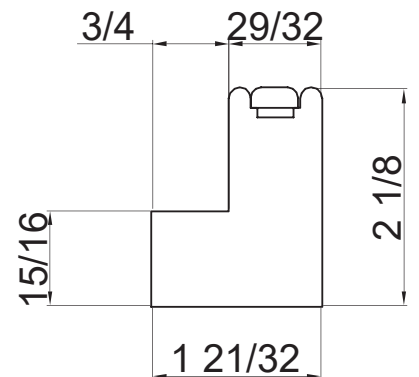
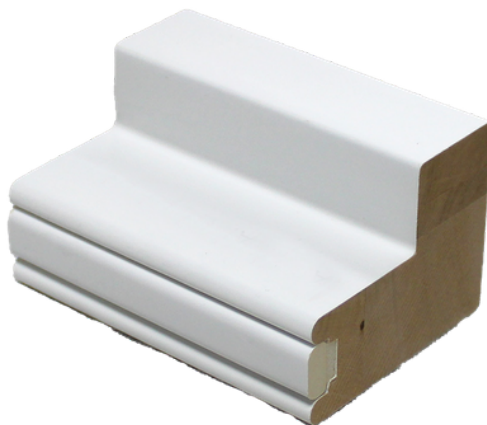

W4022

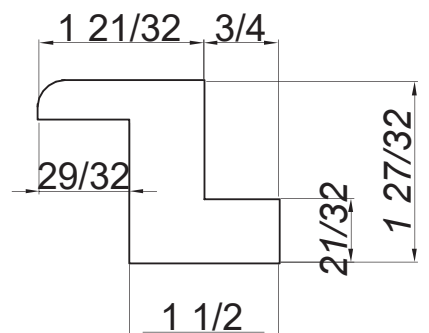



# FRAME TYPES

Z TRIM

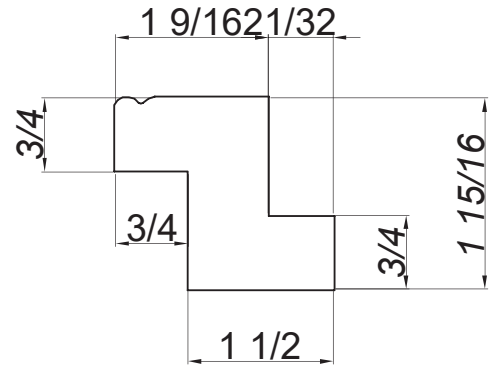

FZ23

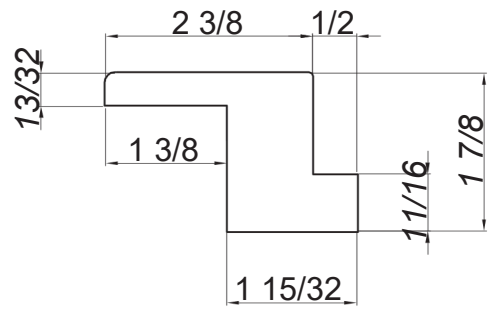

W900

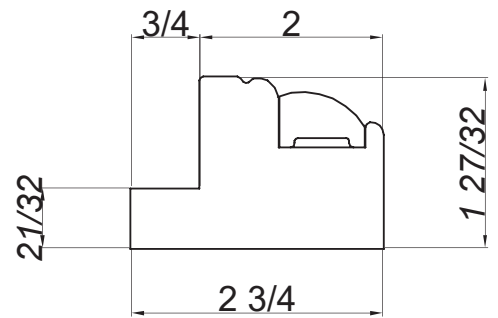

CF20

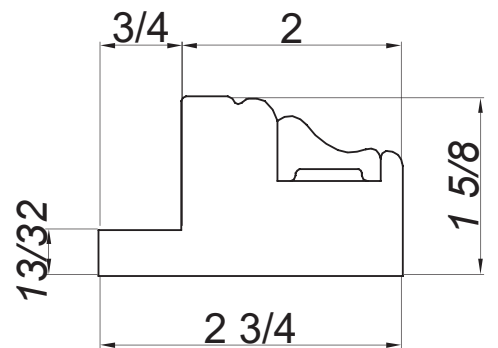

## LOUVER SIZES AND OPTIONS

### CLOSED PANELS



2 1/2" Shutter Louvers



3 1/2" Shutter Louvers



4 1/2" Shutter Louvers

### OPEN PANELS



2 1/2" Shutter Louvers



3 1/2" Shutter Louvers



4 1/2" Shutter Louvers

## TILT ROD OPTIONS



HIDDEN / INVISIBLE  
TILT



OFFSET TILT

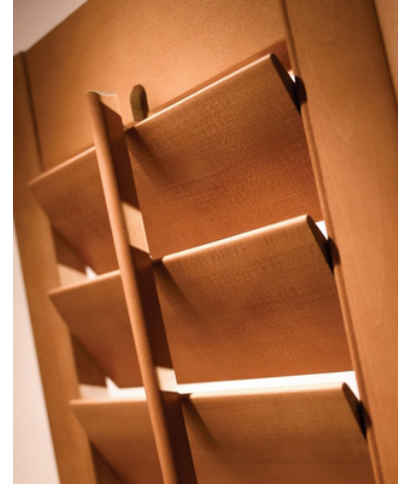

CENTER TILT

## SPLIT TILT ROD

Large louver banks can be split into individually operated banks for better closure without adding a divider rail for panel heights below 70".

Split tilts also provide the added benefit of privacy options.

Split tilt locations can be specified at custom locations for all louver sizes with any tilt rod option, or at manufacturing by default.

50/50 = Split halfway 50/50 CAM = Split halfway above mid-rail  
50/50 CBM = Split halfway below mid-rail

Custom = Advise required split location from the bottom up  
When the panel height surpasses 60 inches, an automatic 50/50 split will be generated at the halfway point.



## D I V I D E R R A I L

Divider rails serve to create a natural break in the window and can be positioned at any designated point on the panels. The location of the divider rail will be adjusted either upwards or downwards by the factory, depending on the louver size and panel height.

For shutters with a height of 70 inches and above, a divider rail is necessary. If precise alignment of your mid-rail is essential, kindly indicate 'Divider-Rail Critical' as there may be a slight variance of up to half a louver in height or position. Specify whether the shutters are positioned in proximity to each other or adjacent, ensuring they are ordered at an equivalent height to align with the divider rail's location. In cases where a precise divider rail placement is crucial, it may require unequal top and bottom rails that are larger than standard dimensions.

### WINDOW SIZE/ INSIDE MOUNT

Measure from the bottom of the window up to the middle of your desired divider rail location.

### FINISH SIZE/ OUTSIDE MOUNT

Measure from the bottom of the shutter/frame up to the middle of your desired divider rail location.

Louver Size	Tolerance
2.5"	+/- 1"
3.5"	+/- 1.5"
4.5"	+/- 2"

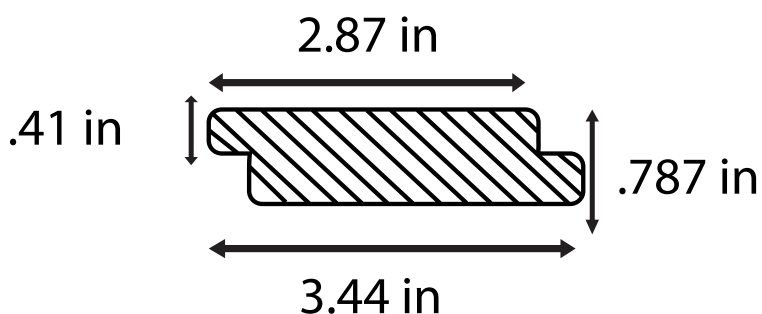

# HINGE TYPES

By default, the factory will match the hinge color to the shutter color unless otherwise specified.

Stainless Steel (surcharge applies)



WHITE



STAINLESS  
STEEL



BRASS



CREAM



BLACK



ANTIQUÉ  
BRASS

## Self Mortise Hinge

Used for regular shutters and multiple panels with T- Posts. Offset screw holes allow for hinges on T- Posts to line up exactly.

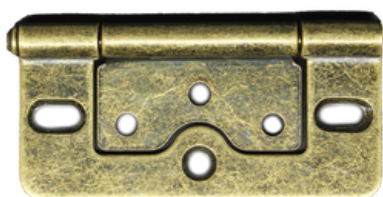
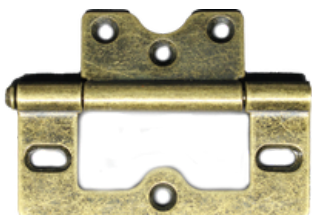

## Rabbated Hinge

Used with rabbeted stile on Bi-Fold hinged and track Bi-Fold panels. Color matched to shutter panels.



PANEL HEIGHT	NUMBER OF HINGES
UP to 39in	2
39in - 59in	3
59in - 78in	4
78in - 98in	5
98in - 118in	6

## SPECIALTY SHAPES

Sunburst Louvers

Horizontal Louvers



Half Circle



Half Circle



Eyebrow



Elongated Eyebrow

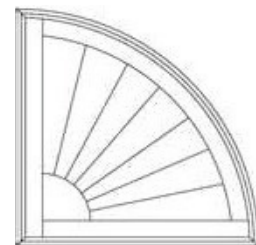

Quarter Circle

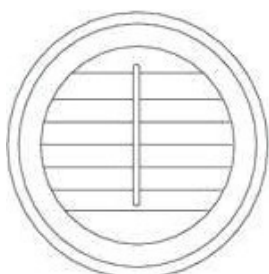

Circle

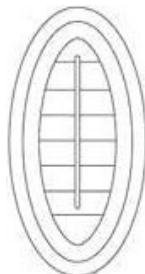

Oval

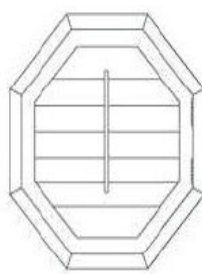

Octagon



Hexagon



Triangle

## CONTOURED ARCHES

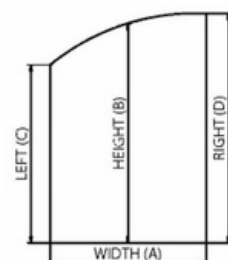
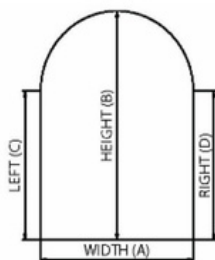
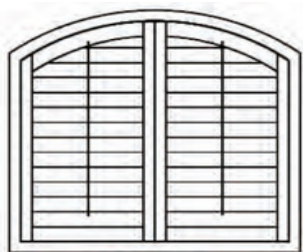

## RAKE

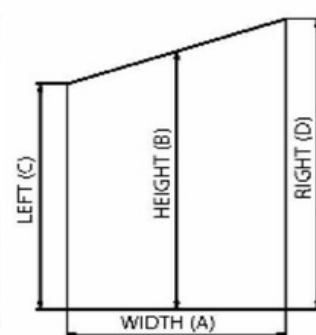
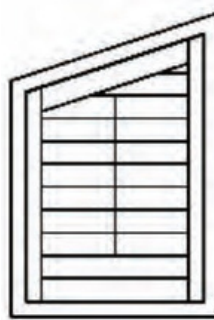
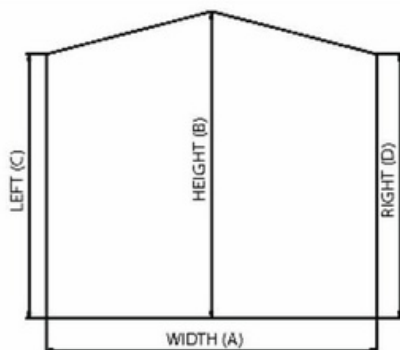

## FRENCH DOOR

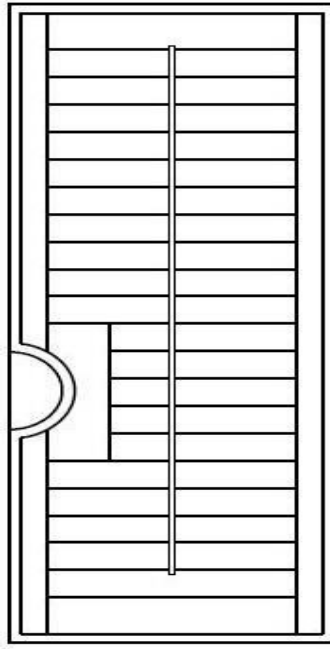
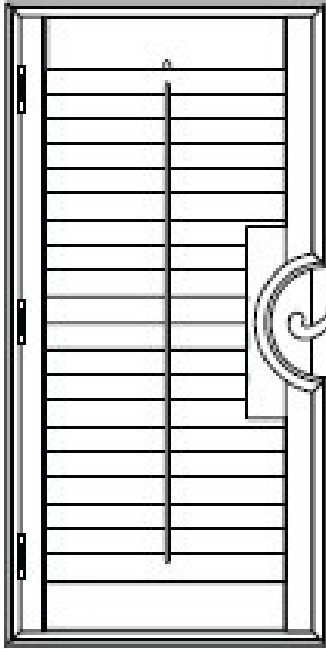

Curved Cut-Out

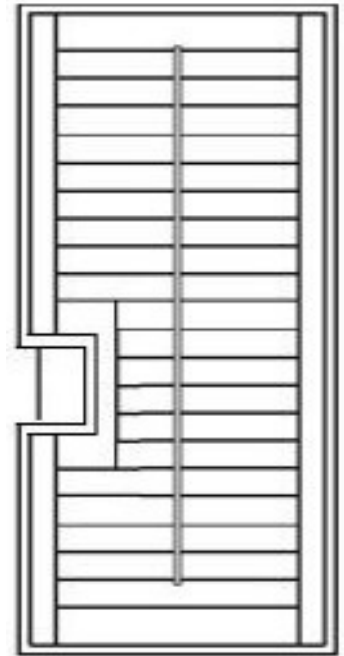

Rectangle Cut-Out

Curved or rectangular cutout complement door handles or traditional door knobs

## BYPASS / BIFOLD TRACK SHUTTERS

Panels slide on top track to open and close. Bypass panels slide left to right. Bifold panels fold accordion style. Ideal for patio or closet doors. Available in flat or decorative.

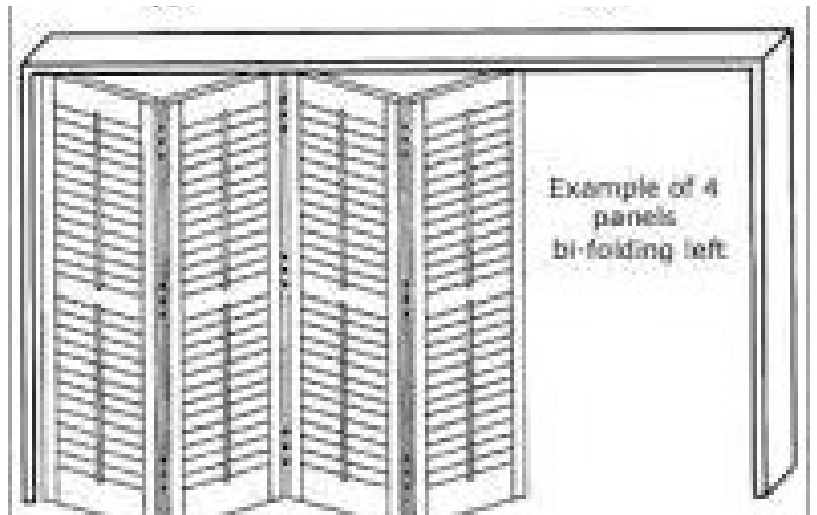

## WARRANTY



We offer the best warranty in the industry, so you can relax knowing that we have you covered. Elegant Window Fashions is committed to providing a superior level of customer service and quality products. As part of this commitment, we offer a No Questions Asked "Consumer Assurance Guarantee" to ensure that your wood shutters meet your expectations and are free from defects. Under our "Consumer Assurance Guarantee," we will cover your wood shutters against any damage, up to one instance per order. In the unlikely event that you require more than one repair, you can rest assured that your blinds will still be covered under our transferable Limited Lifetime Warranty. Our Limited Lifetime Warranty provides coverage against original defects in materials or workmanship. It is important to note that both the "Consumer Assurance Guarantee" and Limited Lifetime Warranty are activated once the product is properly installed and accepted by the consumer. At Elegant Window Fashions, we take pride in our products and stand behind their quality. Repair and replacement will be at our sole discretion, and we are committed to ensuring that you are satisfied with your purchase. For assistance with warranty claims, please contact the original dealer. Should you require product manuals or technical support, we invite you to visit <https://elegantwf.com/contact-us/> or call 888-615-0642. We would like to bring to your attention that repair or replacement of defective items is the sole remedy under this warranty. Repairs shall be executed using comparable or identical parts, and shipping charges are not included in this warranty. Warranty claims must be accompanied by documented proof of purchase, as well as specific details regarding the nature of the problem and the product's location. This warranty is exclusive and supersedes all other obligations, liabilities, or warranties. All other warranties, whether expressed or implied, are explicitly disclaimed. Elegant Windows or Elegant distributors/dealers shall not be liable for incidental or consequential damages, nor any other direct or indirect damage, loss, cost, expense, or fee. Please note that products are not covered for damage resulting from natural disasters or "Acts of God." We would like to draw your attention to the fact that some states do not allow the exclusion or limitation of implied warranties, or incidental or consequential damages. As a result, the above limitation may not apply to your state. \*Note: No Questions Asked warranty applies ONLY to residential application. Commercial orders have a 1 year limited manufacturers warranty. Color fastness 3 years for stains and 5 year for paint.

Thank you for choosing Elegant Window Fashions to be a part of your home!